

TOLEDO FURNITURE

MODULAR WORK STATIONS

"SCHOLASTIC", "EDUCATOR" " KD TABLE" & "TASK" SERIES

PRICE LIST # 109 ZONE # 1

FOB DELIVERED

www.toledofurniture.com

EFFECTIVE December 1 , 2006

This price list supersedes all previous price lists.

TABLE OF CONTENTS

Description	Page
Policy and Services	2
SCHOLASTIC	
Pricing Instructions	3
Single Faced Table	4
Single Faced Table	5
Corner & Printer Table	6
Round Table	7
Double Faced Table	8
Double Faced Table	9
Accessories	10
EDUCATOR	
Pricing Instructions	11
Single Faced Table	12
Double Faced Table	13
Corner, Printer & Round Table	14
Accessories	15
TASK	
Workstation/Accessories	16
KD TABLE	17
KD Table pricing	18
CHAIRS	19
ELECTRICAL	
Pricing Instructions	20
Electrical	21
Electrical	22

TOLEDO FURNITURE INC.

POLICY AND SERVICES #109 - Zone #1

PRICING: All prices are unassembled, F.O.B. Delivered. All orders are subject to final acceptance by Corporate Office. Prices are subject to change without notice. Toledo has the right to make product design changes at any time. Toledo's prices do not include sales, use, excise or similar taxes. Consequently, in addition to the prices specified herein, the amount of any present or future sales, use, excise or similar tax applicable to the manufacture, sale, purchase or use of the goods sold hereunder shall be paid by Buyer. In lieu thereof, Buyer shall provide Seller with a tax exemption certificate acceptable to the applicable taxing authorities.

TERMS OF PAYMENT: Terms are Net 30 Days from date of shipment. A service charge of 1_% per month will be charged for overdue invoices.

MINIMUM ORDERS: Minimum order is \$500.00 Net.

SPECIFICATIONS: Toledo Furniture reserves the right to change any product specifications contained in this price list.

FREIGHT CHARGES: All shipments will be made freight prepaid. All routing will be done solely by the Home Office. If purchaser does not accept delivery of merchandise when ready for shipment, storage fees may be charged to the purchaser

WEIGHT: Weights shown are approximate.

FREIGHT CLAIMS: Freight claims for damaged freight will be handled by the seller when proper documentation is provided by the buyer to seller within 7 days of receipt of shipment. Buyer must provide to sell the original freight bill, signed and dated by the driver with freight damage properly noted on the face of the freight bill. Buyer will hold all damaged parts until released by seller. Failure to document damage at the time of delivery relieves seller from any and all liability for replacement parts. Claims for concealed damage are the responsibility of the buyer and must be filed with the carrier.

PARTIAL SHIPMENTS: Toledo reserves the right to make partial shipments unless otherwise expressly stated herein. All such installments shall be separately invoiced and paid for when due, without regard to subsequent deliveries. Delay in delivery of all shipments shall not relieve Buyer of its obligations to accept remaining deliveries.

SHIPPING TIME: Shipping dates are 75 days after purchase order is released on standard price list items . Toledo makes every effort to meet shipping date requests, but will not be held liable for missed shipping dates. Once items are shipped, Toledo is not responsible for delays caused by the delivering carrier. This includes, but is not limited to, delays in installation proceedings due to slow delivery by carrier. Special (non-price list items) delivery dates will vary depending on the product .

CANCELLATIONS & RETURNS: Orders for "Special" items are not subject to change or cancellation. No return accepted without written consent of the Toledo's Corporate Office. All returned shipments are subject to a re-stocking charge plus all transportation charges incurred by Toledo unless Toledo is at fault. Once production of "Special" items has begun, cancellation of order is subject to Toledo approval. A 15% surcharge will be assessed to approved cancelled items.

CODE RESTRICTIONS: Local building codes vary. It is the purchaser's responsibility to determine that product installation is in accordance with all Local, State and Federal requirements.

LIMITED WARRANTY

Toledo Furniture warrants goods purchased hereunder to be free of defects in materials and workmanship for a period of ten (10) years for the metal and one (1) year for the tops from the date of shipment, hereunder. Toledo's warranty shall not apply in the event goods are damaged as a result of misuse, abuse, neglect, accident, improper application, modification or repair by persons not authorized by Seller, where goods are damaged during shipment. **UNLESS CONSIDERED UNENFORCEABLE OR UNLAWFUL UNDER APPLICABLE LAW:**

A. All implied warranties, including but not limited to warranties or merchantability and fitness for a particular purpose are hereby excluded:

B. Buyer's remedy, if any, for any defective goods shall be limited to a refund by seller or replacement for the goods at seller's option, and shall in no event include damages of any kind, whether incidental, consequential or otherwise.

NO GOODS ACCEPTED FOR RETURN WITHOUT PRIOR APPROVAL. Seller shall have the right to inspect any goods claimed to be defective at Buyer's place of business or require Buyer to return the goods to Seller for inspection on Seller's premises. Transportation charges covering returned goods will be borne by Seller only if such goods are proven to be defective, are covered by this warranty and are returned within the warranty period stated above.



Instructions on Pricing Toledo 's "Scholastic" Modular Workstations

Toledo's "Scholastic" Modular Computer Workstations are sold as either a Free-Standing or Modular (End Starter, Center Adder or End Adder) depending on the requirements of the end user. Each Computer Workstation Model/Part Number consists of a table type abbreviation followed by 4 numbers/sections separated by a "." period. The first section corresponds to the depth of the workstation, the second section corresponds to either the length of or angle of the workstation, the third section corresponds to the height of the workstation and the last section corresponds to the Edge Banding for the workstation. The next few pages provides the details necessary to complete an order for 1 or more workstations. For Example:

To price out a 30" Deep x 38" Wide x 27.5" High Single-Faced Free Standing Workstation with Post Form Front Edge Banding, the Model/Part number will be:

STFS . (1) . (2) . (3) . (4) = STFS . 30 . 36 . 27 . 1 = \$ 827

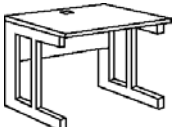
FREE STANDING SINGLE FACED WORKSTATIONS

 30" deep x 27.5" high STFS.30.30.27._	POSTFORM - HPL	PVC - HPL	LBS
	 Option 1 - Post Form Edge In-Stock 27.5" High	 Option 2 - 3mm PVC Edge In-Stock 27.5" High	Weight
	\$ 883	\$ 868	\$ 96
STFS.30.36.27._	\$ 926	\$ 911	\$ 106
STFS.30.42.27._	\$ 976	\$ 961	\$ 114
*STFS.30.48.27._	\$ 1,026	\$ 1,097	\$ 124
*STFS.30.54.27._	\$ 1,076	\$ 1,115	\$ 134
STFS.30.60.27._	\$ 1,126	\$ 1,217	\$ 151
*STFS.30.66.27._	\$ 1,276	\$ 1,261	\$ 160
STFS.30.72.27._	\$ 1,343	\$ 1,328	\$ 170

Example

In-Stock Items (Shaded Above) Have Wrinkle Black Finish And Available In 4-6 Weeks.
*Non-Stock Items Available in 10-12 Weeks.

FREE STANDING SINGLE FACED WORKSTATIONS

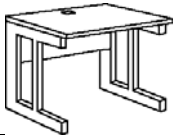
	POSTFORM - HPL		PVC - HPL	LBS Weight
	Option 1 - Post Form Edge		Option 2 - 3mm PVC Edge	
30" deep x 27.5" high	In-Stock 27.5" High Wrinkle Black Finish		In-Stock 27.5" High Wrinkle Black Finish	
STFS.30.30.27._	\$	883	\$ 868	96
STFS.30.36.27._	\$	926	\$ 911	106
STFS.30.42.27._	\$	976	\$ 961	114
*STFS.30.48.27._	\$	1,112	\$ 1,097	124
*STFS.30.54.27._	\$	1,130	\$ 1,115	134
STFS.30.60.27._	\$	1,232	\$ 1,217	151
*STFS.30.66.27._	\$	1,276	\$ 1,261	160
STFS.30.72.27._	\$	1,343	\$ 1,328	170

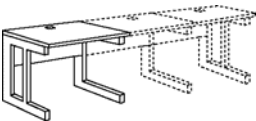

END STARTER SINGLE FACED WORKSTATIONS

	POSTFORM - HPL		PVC - HPL	LBS Weight
	Option 1 - Post Form Edge		Option 2 - 3mm PVC Edge	
30" deep x 27.5" high	In-Stock 27.5" High Wrinkle Black Finish		In-Stock 27.5" High Wrinkle Black Finish	
STES.30.30.27._	\$	866	\$ 851	92
STES.30.36.27._	\$	909	\$ 894	102
STES.30.42.27._	\$	959	\$ 944	110
*STES.30.48.27._	\$	1,020	\$ 1,005	120
*STES.30.54.27._	\$	1,113	\$ 1,098	130
STES.30.60.27._	\$	1,215	\$ 1,200	147
*STES.30.66.27._	\$	1,258	\$ 1,243	156
STES.30.72.27._	\$	1,325	\$ 1,310	166

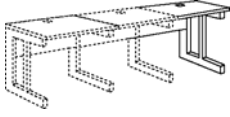

Items Available In 4-6 Weeks. Metal Color- Wrinkle Black , Platinum , Designer Beige & Grey River .

Table Heights	27.5" 29" & 25"					In-Stock
	39"					

END ADDER SINGLE FACED WORKSTATIONS

 30" deep x 27.5" high	POSTFORM - HPL		PVC - HPL	LBS
	 Option 1 - Post Form Edge		 Option 2 - 3mm PVC Edge	Weight
	In-Stock 27.5" High Wrinkle Black Finish		In-Stock 27.5" High Wrinkle Black Finish	
STEA.30.30.27._	\$	682	\$	667 72
STEA.30.36.27._	\$	725	\$	710 82
STEA.30.42.27._	\$	775	\$	760 90
*STEA.30.48.27._	\$	837	\$	822 100
*STEA.30.54.27._	\$	930	\$	915 110
STEA.30.60.27._	\$	1,031	\$	1,016 127
*STEA.30.66.27._	\$	1,074	\$	1,059 136
STEA.30.72.27._	\$	1,141	\$	1,126 146

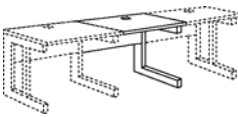
CENTER ADDER SINGLE FACED WORKSTATIONS



 30" deep x 27.5" high	POSTFORM - HPL		PVC - HPL	LBS
	 Option 1 - Post Form Edge		 Option 2 - 3mm PVC Edge	Weight
	In-Stock 27.5" High Wrinkle Black Finish		In-Stock 27.5" High Wrinkle Black Finish	
STCA.30.30.27._	\$	622	\$	607 68
STCA.30.36.27._	\$	665	\$	650 78
STCA.30.42.27._	\$	714	\$	699 86
*STCA.30.48.27._	\$	776	\$	761 96
*STCA.30.54.27._	\$	869	\$	854 106
STCA.30.60.27._	\$	907	\$	892 123
*STCA.30.66.27._	\$	977	\$	962 132
STCA.30.72.27._	\$	1,047	\$	1,032 142

Items Available In 4-6 Weeks. Metal Color- Wrinkle Black , Platinum , Designer Beige & Grey River .

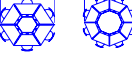

Table Heights	27.5" 29' & 25"					In-Stock
	39"					

"SCHOLASTIC" WORKSTATIONS

ARTICULATING CORNER ADDER WORKSTATION

 26" deep x 27.5" high	P O S T F O R M - H P L		PVC - HPL	LBS
	 Option 1 - Post Form Edge	 Option 2 - 3mm PVC Edge	* In-Stock 27.5" High Wrinkle Black Finish	
Total Cost	Total Cost	Total Cost	Total Cost	Weight
STFR.26.48.27...6	\$ 1,314		\$ 1,284	115
STFR.28.46.27...8	\$ 1,504		\$ 1,474	137

FULL ROUND WORKSTATION (6 or 8)

 26" deep x 27.5" high	P O S T F O R M - H P L		PVC - HPL	LBS
	 Option 1 - Post Form Edge	 Option 2 - 3mm PVC Edge	#VALUE!	
Total Cost	Total Cost	Total Cost	Total Cost	Weight
STFR.26.48.27...6				450
STFR.28.46.27...8	\$ 9,700		\$ 9,630	600

HALF ROUND WORKSTATION (3 or 4)





 26" deep x 27.5" high	P O S T F O R M - H P L		PVC - HPL	LBS
	 Option 1 - Post Form Edge	 Option 2 - 3mm PVC Edge	* In-Stock 27.5" High Wrinkle Black Finish	
Total Cost	Total Cost	Total Cost	Total Cost	Weight
STHR.26.48.27...3	\$ 3,500		\$ 3,296	245
STHR.28.46.27...4	\$ 4,510		\$ 4,331	320

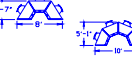

Table Finishes	Wrinkle Black				
	Platinum				
	Grey River Designer				
	Beige				

"SCHOLASTIC" WORKSTATIONS



EXTENDED TRIANGULAR INSIDE CORNER WORKSTATIONS

 30" deep x 27.5" high	P O S T F O R M - H P L		LBS
	 Option 1 - Post Form Edge	Weight	
Total Cost	Total Cost	Total Cost	Total Cost
STETICA.30.90.27..._	\$ 1,512		169



TRIANGULAR OUTSIDE CORNER WORKSTATIONS

 30" deep x 27.5" high	P O S T F O R M - H P L		LBS
	 Option 1 - Post Form Edge	Weight	
Total Cost	Total Cost	Total Cost	Total Cost
STTCRA.30.45.27..._	\$ 583		#REF!



TRIANGULAR INSIDE CORNER WORKSTATIONS

 30" deep x 27.5" high	P O S T F O R M - H P L		LBS
	 Option 1 - Post Form Edge	Weight	
Total Cost	Total Cost	Total Cost	Total Cost
STTICA.30.45.27..._	\$ 1,028		#REF!

TRIANGULAR FULL CORNER WORKSTATIONS

 30" deep x 27.5" high	P O S T F O R M - H P L		LBS
	 Option 1 - Post Form Edge	Weight	
Total Cost	Total Cost	Total Cost	Total Cost
STTFCA.30.90.27..._	\$ 812		#REF!

PRINTER ADDER WORKSTATIONS - Single or Double Faced

 27.5" high	P O S T F O R M - H P L		LBS
	 Option 1 - Post Form Edge	Weight	
Total Cost	Total Cost	Total Cost	Total Cost
SPSA.30.15.27.2	\$ 609		#REF!
SPSA.54.27.27.2	\$ 926		#REF!
SPSA.60.30.27.2	\$ 1,017		#REF!

In-Stock Items (Shaded Above) Have Wrinkle Black Finish And Available In 4-6 Weeks.					
*Non-Stock Items Available in 10-12 Weeks.					
Table Heights	27.5" 25" & 29"				In-Stock
	39"				Add 10% (10-12 weeks delivery)
Table Finishes	Wrinkle Black				In-Stock
	Platinum				Add \$220 net set-up plus 10% upcharge (10-12 weeks delivery)
	Designer Beige				

"SCHOLASTIC" WORKSTATIONS

FREE STANDING DOUBLE FACED WORKSTATION

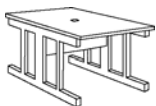

	POSTFORM - HPL				PVC - HPL	LBS
	Option 1 - Post Form Edge				Option 2 - 3mm PVC Edge	
54" deep x 25" 29" or 27.5" high	* In-Stock 27.5" High Wrinkle Black Finish				* In-Stock 27.5" High Wrinkle Black Finish	
STDFS.54.30.27._	\$	1,258			\$	1,233 163
STDFS.54.36.27._	\$	1,308			\$	1,283 177
STDFS.54.42.27._	\$	1,414			\$	1,389 189
STDFS.54.48.27._	\$	1,573			\$	1,548 203
STDFS.54.54.27._	\$	1,625			\$	1,600 217
STDFS.54.60.27._	\$	1,857			\$	1,832 230
STDFS.54.66.27._	\$	1,961			\$	1,936 243
STDFS.54.72.27._	\$	2,110			\$	2,085 257
60" deep tables		Option 1 - Post Form Edge			Option 2 - 3mm PVC Edge	
STDFS.60.30.27._	\$	1,496.00			\$	1,471 170
STDFS.60.36.27._	\$	1,557.00			\$	1,532 186
STDFS.60.42.27._	\$	1,683.00			\$	1,658 200
STDFS.60.48.27._	\$	1,871.00			\$	1,846 216
STDFS.60.54.27._	\$	1,933.00			\$	1,908 232
STDFS.60.60.27._	\$	2,210.00			\$	2,185 263
STDFS.60.66.27._	\$	2,333.00			\$	2,308 278
STDFS.60.72.27._	\$	2,403.00			\$	2,378 294

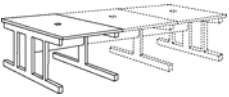
END STARTER DOUBLE FACED WORKSTATION



	POSTFORM - HPL				PVC - HPL	LBS
	Option 1 - Post Form Edge				Option 2 - 3mm PVC Edge	
54" deep x 25" 29" or 27.5" high	* In-Stock 27.5" High Wrinkle Black Finish				* In-Stock 27.5" High Wrinkle Black Finish	
	Total Cos	Metal	Tops	H/W		
STDES.54.30.27._	\$	1,182			\$	1,157 155
STDES.54.36.27._	\$	1,233			\$	1,208 169
STDES.54.42.27._	\$	1,339			\$	1,314 181
*STDES.54.48.27._	\$	1,497			\$	1,472 195
*STDES.54.54.27._	\$	1,549			\$	1,524 209
STDES.54.60.27._	\$	1,782			\$	1,757 238
*STDES.54.66.27._	\$	1,885			\$	1,860 251
STDES.54.72.27._	\$	2,034			\$	2,009 265
60" deep tables		Option 1 - Post Form Edge			Option 2 - 3mm PVC Edge	
STDES.60.30.27.2	\$	1,407.00			\$	1,382 162
STDES.60.36.27.2	\$	1,467.00			\$	1,442 178
STDES.60.42.27.2	\$	1,593.00			\$	1,568 192
STDES.60.48.27.2	\$	1,783.00			\$	1,758 208
STDES.60.54.27.2	\$	1,843.00			\$	1,818 224
STDES.60.60.27.2	\$	2,224.00			\$	2,199 255
STDES.60.66.27.2	\$	2,268.00			\$	2,243 270
STDES.60.72.27.2	\$	2,420.00			\$	2,395 286

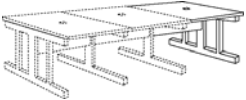

END ADDER DOUBLE FACED WORKSTATION

 54" deep x 27.5" high	POSTFORM - HPL		PVC - HPL	LBS Weight
	 Option 1 - Post Form Edge		 Option 2 - 3mm PVC Edge	
	* In-Stock 27.5" High Wrinkle Black Finish		* In-Stock 27.5" High Wrinkle Black Finish	
STDEA.54.30.27._	\$	864	\$ 839	121
STDEA.54.36.27._	\$	916	\$ 891	135
STDEA.54.42.27._	\$	1,021	\$ 996	147
STDEA.54.48.27._	\$	1,180	\$ 1,155	161
STDEA.54.54.27._	\$	1,231	\$ 1,206	175
STDEA.54.60.27._	\$	1,464	\$ 1,439	204
STDEA.54.66.27._	\$	1,568	\$ 1,543	217
STDEA.54.72.27._	\$	1,716	\$ 1,691	231
60" deep x 27.5" high		Option 1 - Post Form Edge	Option 2 - 3mm PVC Edge	
STDEA.60.30.27.2	\$	1,029.00	\$1,004	128
STDEA.60.36.27.2	\$	1,089.00	\$1,064	144
STDEA.60.42.27.2	\$	1,216.00	\$1,191	158
STDEA.60.48.27.2	\$	1,405.00	\$1,380	174
STDEA.60.54.27.2	\$	1,465.00	\$1,440	190
STDEA.60.60.27.2	\$	1,802.00	\$1,777	221
STDEA.60.66.27.2	\$	1,866.00	\$1,841	236
STDEA.60.72.27.2	\$	2,042.00	\$2,017	252

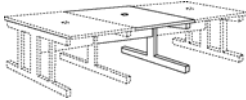
CENTER ADDER DOUBLE FACED WORKSTATION

 54" deep x 27.5" high	POSTFORM - HPL		PVC - HPL	LBS Weight
	 Option 1 - Post Form Edge		 Option 2 - 3mm PVC Edge	
	* In-Stock 27.5" High Wrinkle Black Finish		* In-Stock 27.5" High Wrinkle Black Finish	
STDCA.54.30.27._	\$	817	\$ 792	113
STDCA.54.36.27._	\$	867	\$ 842	137
STDCA.54.42.27._	\$	971	\$ 946	142
STDCA.54.48.27._	\$	1,170	\$ 1,145	159
STDCA.54.54.27._	\$	1,182	\$ 1,157	180
STDCA.54.60.27._	\$	1,416	\$ 1,391	215
STDCA.54.66.27._	\$	1,465	\$ 1,440	235
STDCA.54.72.27._	\$	1,669	\$ 1,644	256
60" deep x 27.5" high			Option 2 - 3mm PVC Edge	
STDCA.60.30.27.2	\$	972.00	\$ 947	120
STDCA.60.36.27.2	\$	1,031.00	\$ 1,006	146
STDCA.60.42.27.2	\$	1,156.00	\$ 1,131	153
STDCA.60.48.27.2	\$	1,392.00	\$ 1,367	172
STDCA.60.54.27.2	\$	1,406.00	\$ 1,381	195
STDCA.60.60.27.2	\$	1,752.00	\$ 1,727	232
STDCA.60.66.27.2	\$	1,836.00	\$ 1,811	254
STDCA.60.72.27.2	\$	1,959.00	\$ 1,934	277

In-Stock Items (Shaded Above) Have Wrinkle Black Finish And Available In 4-6 Weeks.

*Non-Stock Items Available in 10-12 Weeks.

Toledo Furniture

"SCHOLASTIC" ACCESSORIES

CPU HOLDER - FIXED

	Adjustable Width and Height. Color is Black.				
	See Note 1 Below.				
	Width	Height	Depth	Price	Wt.
CPUHOLDER	6"-9.25"	15"-21"	N/A	\$ 80	8
SLIMCPU	3"-5.5"	15"-21"	N/A	\$ 155	8

CLOSURE PANELS - Perforated Steel

	Color will match table. Available for 25" , 27.5 or 29" C legs				
	Width	Height	Depth	Price	Wt.
PF27.5	8"	19-5/8"	1-1/4"	\$ 185	1
PF27.5-SL	8"	19-5/8"	1-1/4"	\$ 80	1

KEYBOARD DRAWER/TRAY

	Slide Out Keyboard Drawer made from 11/16" particle board with eased front edge. Can be installed 1.5" - 2.5" below desktop. Color is Textured Black.				
	Width	Height	Depth	Price	Wt.
KBD21	21"	Adj.	14"	ASK	8
KBD30	30"	Adj.	14"	FACTOR	15

DELUXE MONITOR/PROJECTOR ARM

	Can handle up to 150 lbs. Platform and Arm swivels 360 degrees. Platform is 1" thick. Pivots are made with bronze bushings. Comes in two arm lengths: 12" and 18". Color is Black.				
	Width	Height	Depth	Price	Wt.
DMA12	12"	N/A	12"	\$ 1,239	21
DMA18	12"	N/A	18"	\$ 1,380	32

MONITOR RETROFIT KIT/UPGRADE

	Package includes: Monitor Support, Keyboard Tray, Tinted/Tempered Viewing Glass, Glare Shield and Trim Grommet. Does not include work surface/workstation.				
	Width	Height	Depth	Price	Wt.
MON-S	22"	N/A	13"	\$ 1,380	30
MON-F	22"	N/A	10"	\$ 162	30
MON-R	22"	N/A	13"	\$ 1,128	30
MON-CPUH	7"-11"	N/A	N/A	\$ 350	5

MONITOR/PROJECTOR TIERED SHELF UNIT

	This unit is attached to the rear portion of E-Tech tables to provide additional table space for monitors, projectors, etc. Brackets and Top will match table to be installed on. Custom Widths Available.				
	Width	Height	Depth	Price	Wt.
TSU1612	12"	9-7/8"	16"	\$ 260	7
TSU1644	44"	9-7/8"	16"	\$ 445	22
TSU1674	74"	9-7/8"	16"	\$ 575	35

"S" CURVE WORKSURFACE UPGRADE

	This upgrades the standard square workstation to a workstation with the front edge in a custom "S" curve configuration. Front edge badning will be PVC.				
	ADD TO TOP				
	Width	Height	Depth	Price	
SCURVE-	30-48	N/A	30"	\$ 50	
SCURVE-	54-72	N/A	30"	\$ 80	

MODESTY PANEL

	This modesty panel is installed underneath the existing raceway, between the legs to provide additional privacy/protection underneath the table. Color is same as table metal color.				
	Width	Height	Depth	Price	Wt.
MOP34	34"	10"	3"	\$ 82	
MOP40	40"	10"	3"	\$ 92	

CPU HOLDERS- RACK & FLOOR MODELS

	CPU-R- CPU Rack two pieces CPU-F- Cpu Holder floor model with glides Heavy-Duty Cup Holder rack under the desk 23 3/4" High x 18" Deep x 6 1/2" to 10" Wide				
	Width	Height	Depth	Price	Wt.
CPU-R	6.5-10"	21"	18"	\$ 145	18
CPU-F	6.5-10"	14"	18"	\$ 148	20

ADA Brackets

	Adjusts height of table to accommodate wheelchairs. Adjustable Height (1"-10") Color will match table. Set of two.				
	Width	Height	Depth	Price	Wt.
ADA18	2"	Adj.	18"	\$ 85	10

HEAVY DUTY CASTERS

	Each Caster has a 200# weight capacity. All Nylon Rounded Wheels. Available with or without brake. 1/2X 13- 1 1/2 STEM- 3 1/2 HIGH				
	Diameter	Brake	Material	Price	Wt.
CASTER3P	3"	No	Plastic	\$ 65	2
CASTER3PB	3"	Yes	Plastic	\$ 72	2

DRAFTING STATION UPGRADE

	lamiate Darrafting top with fixed laminate sides .				
	Width	Height	Depth	Price	Wt.
DT3632	36"	Fixed	32"	ASK	40
FACTORY					

STUDY PANEL UPGRADE

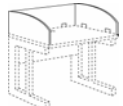
	Includes privacy panels on three sides Does not include work surface/workstation. Hardware Color will be Wrinkle Black. Standard Wilson Art Laminate See Source Book for Product Specifications Available in HLP or Melamine Wt. (lbs): 70				
	Width	Height	Depth	HPL	
STUDY-SF	30-48	20"	24"	ASK	FACTORY
STUDY-DF	30-48	20"	24"	ASK	FACTORY

TOP UPGRADE



	Upgrade table tops to have post-form both front AND rear!				
	Wt. (lbs):				
	Width	Height	Depth	HPL	MEL
TOP-UPGRADE	30-72"		32"	\$125	N/A

Instructions on Pricing E-Tech's "EDUCATOR" Tables

Toledo "Educator" Modular Computer Workstations are sold as either a Free-Standing or Modular (End Starter, Center Adder or End Adder) depending on the requirements of the end user. Each Workstation Model/Part Number consists of a workstation type abbreviation followed by 4 numbers/sections separated by a "." period. The first section corresponds to the depth of the workstation, the second section corresponds either to the length of the workstation or the angle of corner unit, the third section corresponds to the height of the workstation and the last section corresponds to the Edge Banding for the workstation. The next few pages provides the details necessary to complete an order for 1 or more workstations. For Example:

If you wanted to price out a 30" Deep x 44" Wide x 27.5" Fixed Height Single-Faced Free Standing Workstation with Post Form Front Edge Banding, the Model/Part number would be:

ETFS . (1) . (2) . (3) . (4) = ETFS . 30 . 42 . 27 . 1 = \$ 460

	POSTFORM - HPL		LBS
			Weight based on 30" Depth
	Option 1 - Post Form Edge - 1.25" Thick H.P. Lam 30" Deep Fixed 27.5" Height	30" Deep Adjustable	
ETFS.30.30.____	\$ 422	\$ 442	64
ETFS.30.36.____	\$ 463	\$ 483	73
ETFS.30.42.____	\$ 482	\$ 502	81

IN-STOCK ITEMS (Shaded Above) HAVE WRINKLE BLACK FINISH AND AVAILABLE IN 4-6 WEEKS. CONTACT FACTORY FOR LEAD TIME AND INFORMATION ON OTHER COLORS.

FREE STANDING SINGLE FACED WORKSTATIONS

	POSTFORM - HPL					PVC - MELAMINE		LBS Weight based on 30" Depth
	Option 1 - Post Form Edge - 1.25" Thick H.P. Laminate					Option 2 - 3mm PVC Edge - 1" Thick Melamine		
	30" Deep Fixed 27.5" Height	30" Deep Adjustable Height (25" to 32")				27" Deep Fixed 27.5" Height	27" Deep Adjustable Height (25" to 32")	
ETFS.30.30.____	\$ 422	\$ 442.00				\$ 392	\$ 412	64
ETFS.30.36.____	\$ 463	\$ 483.00				\$ 433	\$ 453	73
ETFS.30.42.____	\$ 482	\$ 502.00				\$ 452	\$ 472	81
ETFS.30.48.____	\$ 513	\$ 533.00				\$ 483	\$ 503	116
ETFS.30.60.____	\$ 583	\$ 603.00				\$ 553	\$ 573	129

END STARTER SINGLE FACED WORKSTATIONS

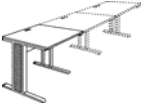
	POSTFORM - HPL					PVC - MELAMINE		LBS Weight based on 30" Depth
	Option 1 - Post Form Edge - 1.25" Thick H.P. Laminate					Option 2 - 3mm PVC Edge - 1" Thick Melamine		
	30" Deep Fixed 27.5" Height	30" Deep Adjustable Height (25" to 32")				27" Deep Fixed 27.5" Height	27" Deep Adjustable Height (25" to 32")	
ETES.30.30.____	\$ 424	\$ 444				\$ 394	\$ 414	64
ETES.30.36.____	\$ 466	\$ 486				\$ 436	\$ 456	73
ETES.30.42.____	\$ 517	\$ 537				\$ 487	\$ 507	81
ETES.30.48.____	\$ 517	\$ 537				\$ 487	\$ 507	116
ETES.30.60.____	\$ 580	\$ 600				\$ 550	\$ 570	129

END ADDER SINGLE FACED WORKSTATIONS

	POSTFORM - HPL					PVC - MELAMINE		LBS Weight based on 30" Depth
	Option 1 - Post Form Edge - 1.25" Thick H.P. Laminate					Option 2 - 3mm PVC Edge - 1" Thick Melamine		
	30" Deep Fixed 27.5" Height	30" Deep Adjustable Height (25" to 32")				27" Deep Fixed 27.5" Height	27" Deep Adjustable Height (25" to 32")	
ETEA.30.30.____	\$ 372	\$ 392				\$ 342	\$ 362	53
ETEA.30.36.____	\$ 404	\$ 424				\$ 374	\$ 394	62
ETEA.30.42.____	\$ 433	\$ 453				\$ 403	\$ 423	70
ETEA.30.48.____	\$ 455	\$ 475				\$ 425	\$ 445	107
ETEA.30.60.____	\$ 527	\$ 547				\$ 497	\$ 517	118

CENTER ADDER SINGLE FACED WORKSTATIONS

	POSTFORM - HPL					PVC - MELAMINE		LBS Weight based on 30" Depth
	Option 1 - Post Form Edge - 1.25" Thick H.P. Laminate					Option 2 - 3mm PVC Edge - 1" Thick Melamine		
	30" Deep Fixed 27.5" Height	30" Deep Adjustable Height (25" to 32")				27" Deep Fixed 27.5" Height	27" Deep Adjustable Height (25" to 32")	
ETCA.30.30.____	\$ 368	\$ 388				\$ 338	\$ 358	53
ETCA.30.36.____	\$ 353	\$ 373				\$ 323	\$ 343	62
ETCA.30.42.____	\$ 397	\$ 417				\$ 367	\$ 387	70
ETCA.30.48.____	\$ 424	\$ 444				\$ 394	\$ 414	107
ETCA.30.60.____	\$ 490	\$ 510				\$ 460	\$ 480	118

METAL TO HAVE WRINKLE BLACK FINISH AND AVAILABLE IN 4-6 WEEKS.

FREE STANDING DOUBLE FACED WORKSTATIONS

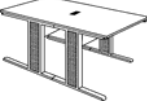
 Tables 27.5" High or Adj.	POSTFORM - HPL					PVC - MELAMINE		LBS Weight based on 54" Depth
	Option 1 - Post Form Edge - 1.25" Thick H.P. Laminate					Option 2 - 3mm PVC Edge - 1" Think Melamine		
	30" Deep Fixed 27.5" Height	30" Deep Adjustable Height (25" to 32")				27" Deep Fixed 27.5" Height	27" Deep Adjustable Height (25" to 32")	
ETDFS...30..._	N/A	N/A				N/A	N/A	127
ETDFS...36..._	N/A	N/A				N/A	N/A	145
ETDFS...42..._	N/A	N/A				N/A	N/A	161

END STARTER DOUBLE FACED WORKSTATIONS

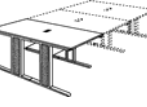
 Tables 27.5" High or Adj.	POSTFORM - HPL					PVC - MELAMINE		LBS Weight based on 30" Depth
	Option 1 - Post Form Edge - 1.25" Thick H.P. Laminate					Option 2 - 3mm PVC Edge - 1" Think Melamine		
	30" Deep Fixed 27.5" Height	30" Deep Adjustable Height (25" to 32")				27" Deep Fixed 27.5" Height	27" Deep Adjustable Height (25" to 32")	
ETDES...30..._	N/A	N/A				N/A	N/A	127
ETDES...36..._	N/A	N/A				N/A	N/A	145
ETDES...42..._	N/A	N/A				N/A	N/A	161

END ADDER DOUBLE FACED WORKSTATIONS

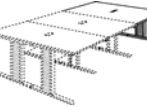
 Tables 27.5" High or Adj.	POSTFORM - HPL					PVC - MELAMINE		LBS Weight based on 54" Depth
	Option 1 - Post Form Edge - 1.25" Thick H.P. Laminate					Option 2 - 3mm PVC Edge - 1" Think Melamine		
	30" Deep Fixed 27.5" Height	30" Deep Adjustable Height (25" to 32")				27" Deep Fixed 27.5" Height	27" Deep Adjustable Height (25" to 32")	
ETDEA...30..._	N/A	N/A				N/A	N/A	105
ETDEA...36..._	N/A	N/A				N/A	N/A	123
ETDEA...42..._	N/A	N/A				N/A	N/A	139

CENTER ADDER DOUBLE FACED WORKSTATIONS

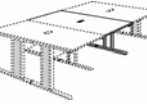
 Tables 27.5" High or Adj.	POSTFORM - HPL					PVC - MELAMINE		LBS Weight based on 54" Depth
	Option 1 - Post Form Edge - 1.25" Thick H.P. Laminate					Option 2 - 3mm PVC Edge - 1" Think Melamine		
	30" Deep Fixed 27.5" Height	30" Deep Adjustable Height (25" to 32")				27" Deep Fixed 27.5" Height	27" Deep Adjustable Height (25" to 32")	
ETDCA...30..._	N/A	N/A				N/A	N/A	105
ETDCA...36..._	N/A	N/A				N/A	N/A	123
ETDCA...42..._	N/A	N/A				N/A	N/A	139

CLOSURE PANELS - Perforated Steel

	Choice of colors: Black or Grey. Preforated Metal Other colors available at additional cost.			
		PRICE		
PANEL-E	\$	28.00		

IN-STOCK ITEMS (Shaded Above) HAVE WRINKLE BLACK FINISH AND AVAILABLE IN 4-6 WEEKS.

EXTENDED TRIANGULAR INSIDE CORNER WORKSTATIONS

 Tables 27.5" High or Adj. ETETICA...90...	POSTFORM - HPL					PVC - MELAMINE		LBS Weight based on 30" Depth
	Option 1 - Post Form Edge - 1.25" Thick H.P. Laminate					Option 2 - 3mm PVC Edge - 1" Think Melamine		
	30" Deep Fixed 27.5" Height	30" Deep Adjustable Height (25" to 32")				27" Deep Fixed 27.5" Height	27" Deep Adjustable Height (25" to 32")	
	\$ 961	\$ 992				\$ 936	\$ 967	117

EXTENDED TRIANGULAR INSIDE CORNER WORKSTATIONS

 Tables 27.5" High or Adj. EPSA.27.13...2 EPSA.30.15...2 EPSA.54.27...2 EPSA.60.30...2	POSTFORM - HPL					PVC - MELAMINE		LBS Weight based on 30" Depth
	Option 1 - Post Form Edge - 1.25" Thick H.P. Laminate					Option 2 - 3mm PVC Edge - 1" Think Melamine		
	30" Deep Fixed 27.5" Height	30" Deep Adjustable Height (25" to 32")				27" Deep Fixed 27.5" Height	27" Deep Adjustable Height (25" to 32")	
	ASK FACTORY	ASK FACTORY				ASK FACTORY	ASK FACTORY	43
	ASK FACTORY	ASK FACTORY				ASK FACTORY	ASK FACTORY	43
	ASK FACTORY	ASK FACTORY				ASK FACTORY	ASK FACTORY	86
	ASK FACTORY	ASK FACTORY				ASK FACTORY	ASK FACTORY	86

FULL ROUND WORKSTATION (6 or 8)

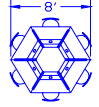
 Tables 27.5" High or Adj. ETR.26.48...6	POSTFORM - HPL					PVC - MELAMINE		LBS Weight based on 30" Depth
	Option 1 - Post Form Edge - 1.25" Thick H.P. Laminate					Option 2 - 3mm PVC Edge - 1" Think Melamine		
	Fixed 27.5" Height	Adjustable Height (25" to 32")				Fixed 27.5" Height	Adjustable Height (25" to 32")	
	\$ 3,778	\$ 3,679				\$ 3,688	\$ 3,589	540

HALF ROUND WORKSTATION (3 or 4)

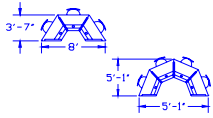
 Tables 27.5" High or Adj. ETHR.26.48...3 ETHR.28.46...4	POSTFORM - HPL					PVC - MELAMINE		LBS Weight based on 30" Depth
	Option 1 - Post Form Edge - 1.25" Thick H.P. Laminate					Option 2 - 3mm PVC Edge - 1" Think Melamine		
	Fixed 27.5" Height	Adjustable Height (25" to 32")				Fixed 27.5" Height	Adjustable Height (25" to 32")	
	\$ 1,963	\$ 2,037				\$ 1,918	\$ 1,992	281
	\$ 2,688	\$ 2,585				\$ 2,628	\$ 2,525	239

PRINTER STNADS FOR HALF/FULL ROUND WORKSTATIONS

 Tables 27.5" High ETPFR.40.40.20...6 ETPFR.64.64.20...8 ETPHR.20.40.20...3 ETPHR.32.64.20...4	POSTFORM - HPL					PVC - MELAMINE		LBS Weight based on 30" Depth
	Option 1 - Post Form Edge - 1.25" Thick H.P. Laminate					Option 2 - 3mm PVC Edge - 1" Think Melamine		
	Fixed 27.5" Height					Fixed 27.5" Height		
	\$ 1,615				\$ 1,555		300	
	\$ 2,005				\$ 1,945		350	
	\$ 967				\$ 907		150	
	\$ 1,162				\$ 1,102		200	

IN-STOCK ITEMS (Shaded Above) HAVE WRINKLE BLACK FINISH AND AVAILABLE IN 4-6 WEEKS.
CONTACT FACTORY FOR LEAD TIME AND INFORMATION ON OTHER COLORS.

Toledo Furniture

"EDUCATOR" ACCESSORIES

CPU HOLDER

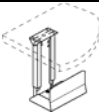
	Adjustable Width and Height. Color is Black.				
	See Note 1 Below.				
	Width	Height	Depth	Price	Wt.
CPUHOLDER	6"-9.25"	15"-21"	N/A	\$ 70	8
SLIMCPU	3"-5.5"	15"-21"	N/A	\$ 150	7

KEYBOARD DRAWER/TRAY

	Slide Out Keyboard Drawer made from 11/16" particle board with eased front edge. Can be installed 1.5" - 2.5" below desktop. Color is Textured Black.				
	Width	Height	Depth	Price	Wt.
	KBD21	21"	Adj.	14"	ASK
KBD30	30"	Adj.	14"	FACTC	15

CLOSURE PANELS - Perforated Steel

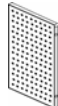
	Choice of colors: Black or Grey. Other colors available at additional cost.				
	Width	Height	Depth	Price	Wt.
	PANEL-E			\$ 28	1

DELUXE MONITOR/PROJECTOR ARM

	Can handle up to 150 lbs. Platform and Arm swivels 360 degrees. Platform is 1" thick. Pivots are made with bronze bushings. Comes in two arm lengths: 12" and 18". Color is Black.				
	Width	Height	Depth	Price	Wt.
	DMA12	12"	N/A	12"	\$ 1,240
DMA18	12"	N/A	18"	\$ 1,380	32

MONITOR/PROJECTOR TIERED SHELF UNIT

	This unit is attached to the rear portion of E-Tech tables to provide additional table space for monitors, projectors, etc. Brackets and Top will match table to be installed on. Custom Widths Available.				
	Width	Height	Depth	Price	Wt.
	TSU1212	12"	9-7/8"	12"	\$ 237
TSU1244	44"	9-7/8"	12"	\$ 420	22
TSU1274	74"	9-7/8"	12"	\$ 518	35

"S" CURVE WORKSURFACE UPGRADE

					
	Add to Top List Price				
	Width	Height	Depth	Price	Wt.
SCURVE-__	30-48	N/A	30"	\$ 60	0
SCURVE-__	54-72	N/A	30"	\$ 90	0

TASK WORKSTATION

	27" Deep x 38" Wide x 29" Tall Workstation Leg Color is Smooth Black with Grey Plastic Covering Wire Management in Leg. Top Color is Light Grey with Black Edging.				
	Width	Height	Depth	Price	Wt.
TASK.27.38.29.T	38"	29"	27"	\$ 315	70

KEYBOARD DRAWER/TRAY

	Slide Out Keyboard Drawer made from 11/16" particle board with eased front edge Can be installed 1.5" - 2.5" below desktop Color is Textured Black.				
	Width	Height	Depth	Price	Wt.
KBD21	21"	Adj.	14"	ASK	53
KBD30	30"	Adj.	14"	FACTC	60

DELUXE MONITOR/PROJECTOR ARM

	Can handle up to 150 lbs. Platform and Arm swivels 360 degrees. Platform is 1" thick. Pivots are made with bronze bushings. Comes in two arm lengths: 12" and 18". Color is Black.				
	Width	Height	Depth	Price	Wt.
DMA12	12"	N/A	12"	ASK	<2
DMA18	12"	N/A	18"	FACTOR	2

	Can handle up to 150 lbs. Platform and Arm swivels 360 degrees. Platform is 1" thick. Pivots are made with bronze bushings. Comes in two arm lengths: 12" and 18". Color is Black.				
	Width	Height	Depth	Price	Wt.
DMA12	12"	N/A	12"	\$ 1,126	21
DMA18	12"	N/A	18"	\$ 1,255	32

NOTE 1: Verify leg & knee space before ordering compo

SWIVEL POSTURE CHAIR

	Oversized seat (21"W x 19"D) Pneumatic height adjustment (16"-21") Carpet casters Available in Black, Bourdeaux, Marine and Smoke Grade 1 Fabric with black frame. Other fabric grades and colors available at an additional cost.		
	Description	Price	Wt.
SPC	Swivel Posture Chair	\$ 372	

SWIVEL POSTURE CHAIR w/ARMS

	Oversized seat (21"W x 19"D) Pneumatic height adjustment (16"-21") Carpet casters Available in Black, Bourdeaux, Marine and Smoke Grade 1 Fabric with black frame. Other fabric grades and colors available at an additional cost.		
	Description	Price	Wt.
SPCA	Posture Chair w/ Arms	\$ 485	

SWIVEL COMPUTER TASK CHAIR

	Contoured seat pan and back. Pneumatic height adjustment (17"-22") 5 Star base with Casters Black Frame with Black seat pan and back. Fabric and other colors available at an additional cost.		
	Description	Price	Wt.
CTC-P	High Density Plastic	\$ 263	
CTC-F	Grade 2 Fabric	\$ 386	

ARMLESS STACKING CHAIR

	Contoured seat pan and back. Stackable 4 Point base with floor glides. Black/Silvervein Frame with Black seat pan and back. Fabric and other colors available at an additional cost.		
	Description	Price	Wt.
ASC-P	High Density Plastic	\$ 157	
ASC-F	Grade 2 Fabric	\$ 280	

TOLEDO FURNITURE PRICING "SCHOLASTIC" AND "EDUCATOR" ELECTRICAL

Instructions on Pricing E-Tech Electrical

Electrical Accessories for E-Tech's "Scholastic" and "Educator" Series of Modular Computer Workstations are sold as an add-on option. Single workstations normally have one Single Junction Block with two (2) Duplex Receptacles. Double workstations normally have two (2) Single Junction Blocks with four (4) Duplex Receptacles. When designing and ordering an Electrical system, start with the workstation farthest from the power source. Order a Power Outlet System with enough cable length to reach the next Power Outlet Junction Block/System. Continue until you have reached the last workstation (closest to the power source), then order a Power Outlet System with enough cable length to reach the end of the table. Lastly, order an End Power Feed long enough to reach the Wall/Floor Plug/Box from the end of the table. Standard Product consists of 8-Wire 4-Circuit system with a shared ground. An 8-Wire 3-Circuit system with separate grounds is also available upon request.

Electrical connection to building must be completed by a licensed electrician. All electrical based on 20 amp circuits, plugs and receptacles. The buyer is responsible to determine the number of circuits required based on the electrical demands on the equipment. The next page, "Electrical", provides the details necessary to price out all the necessary components of the electrical system. For example:

If you wanted to price out the Electrical System for the Modular Workstation below you would need to order:

PART #	QUANTITY	DESCRIPTION	UNIT PRICE
ESS.42.4	2	Single Power Outlet System	\$ 139
ESS.24.4	3	Single Power Outlet System	\$ 126
EPFH.36.4 or EPFW.38.4	1	Hard Wired or Plug End Power Feed	\$ 90

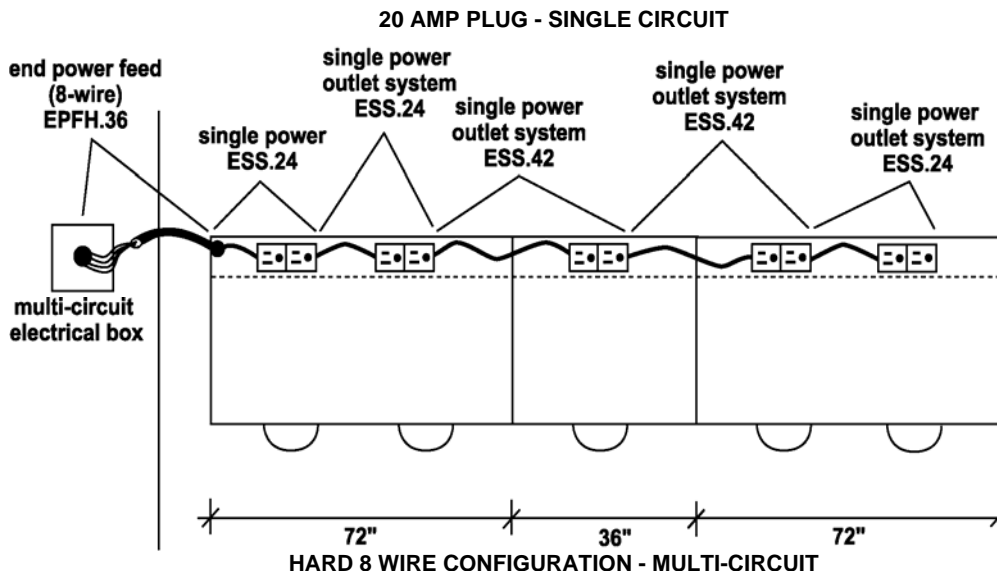

SINGLE POWER OUTLET SYSTEM

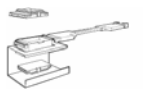
	System consists of Power Module Holder, Single Junction Block, 2-Duplex Receptacles and attached cable. 4-Circuit System with shared ground. 3-Circuit System Available.	
	Length	Price
ESS.18._	18" Total Length	\$ 190
ESS.24._	24" Total Length	\$ 196
ESS.30._	30" Total Length	\$ 203
ESS.36._	36" Total Length	\$ 209
ESS.42._	42" Total Length	\$ 216
ESS.48._	48" Total Length	\$ 226
ESS.54._	54" Total Length	\$ 234
ESS.60._	60" Total Length	\$ 240
ESS.66._	66" Total Length	\$ 250
ESS.72._	72" Total Length	\$ 257

PASS THROUGH JUMPER CABLE (Male x Female)

	Pass Through Jumper Cable Male x Female Connections 4-Circuit System with shared ground. 3-Circuit System Available.	
	Length	Price
EMF.18._	18" Total Length	\$ 76
EMF.24._	24" Total Length	\$ 81
EMF.30._	30" Total Length	\$ 86
EMF.36._	36" Total Length	\$ 92
EMF.42._	42" Total Length	\$ 97
EMF.48._	48" Total Length	\$ 107
EMF.54._	54" Total Length	\$ 115
EMF.60._	60" Total Length	\$ 119
EMF.66._	66" Total Length	\$ 125
EMF.72._	72" Total Length	\$ 182

END POWER FEED - PLUG IN

	End Power Feed - Plug In Style 20 amp Wall Plug x Male Connector Comes with 24" Flex Cord Available in Angle or Straight Plug. Handle power for 1 circuit.	
	Length	Price
EPFW.38A._	38" Total Length w/ Angle Plug	\$ 146
EPFW.52A._	52" Total Length w/ Angle Plug	\$ 163
EPFW.72A._	72" Total Length w/ Angle Plug	\$ 203

END POWER FEED - HARD WIRED

	End Power Feed - Hard Wire Style Bare Wires x Male Connector 114" Length Designed for Ceiling Entry Designate Straight or Angle Fitting. 4-Circuit System with shared ground. 3-Circuit System Available.	
	Length	Price
EPFH.24._	24" Total Length - Wall Entry	\$ 120
EPFH.36._	36" Total Length - Wall Entry	\$ 132
EPFH.48._	48" Total Length - Wall Entry	\$ 146
EPFH.60._	60" Total Length - Wall Entry	\$ 158
EPFH.72._	72" Total Length - Wall Entry	\$ 193
EPFH.114._	114" Total Length - Ceiling Entry	\$ 205

FLEXIBLE END POWER FEED CABLE MANAGER

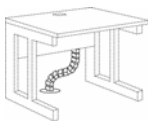
	This Plastic Flexible Cable Management System is ideal of routing the Power Feed Cable Down to the Floor. Length is Adjustable by Removing Individual Disks. Include Weighted Base.	
	Description	Price
EFEPFCM-S.31	31.5" Long (Square)	\$ 147
EFEPFCM-S.39	39.5" Long (Square)	\$ 177
EFEPFCM-R.31	31.5" Long (Round)	\$ 159
EFEPFCM-R.39	39.5" Long (Round)	\$ 189

TOLEDO FURNITURE

"SCHOLASTIC" AND "EDUCATOR" ELECTRICAL

110V OUTLET AND DATA JACK END CAP

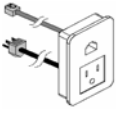
	This End Cap Replaces the Standard Blank End Cap. Located on the Table Support Arm Provides One RJ-45 Jack and One 110V Outlet. NOT FOR EDUCATOR.	
	Description	Price
	EODJ.6.6	With 6' Long Cables
EODJ.9.9	With 9' Long Cables	\$ 154

DUAL MICROPHONE/HEADSET JACKS

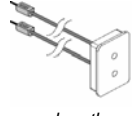
	This End Cap Replaces the Standard Blank End Cap. Located on the Table Support Arm Provides Two Microphone/Headset Jacks. NO FOR EDUCATOR.	
	Description	Price
	EDMJ.6	With 6' Long Cables

110V OUTLET AND DATA CENTER

	This Replaces Standard Wire Grommet. Provides Two 110V Outlets and Location for 2 Data Jack (Not Included). Adapter Included. Must be Ordered at the Same Time as Table. Standard 15 Amp Plug In Power Feed Can be Located in Center with Raceway Modification.	
	Description	Price
	EODC	With 36" Power Feed
DATAJACK	Data Jack with 6' Cable	xxx
	Each Additional 1' of CAT5 Cable	xxx

110V OUTLET AND DATA SPHERE

	To be Installed at Rear of Table. Provides Two 110V Outlets and Location for 2 Data Jack (Not Included). Adapter Included. Must be Ordered at the Same Time as Table. Standard 15 Amp Plug In Power Feed Installer Must Modify Raceway.	
	Description	Price
	EODS	With 36" Power Feed
DATAJACK	Data Jack with 6' Cable	\$ 95

SINGLE FACED TOPS



1-1/4" thick, 3-ply particleboard with .050" high pressure laminate face and .020" phenolic backer on the underside. One long edge will be Post Form (laminated). Remaining edges will be banded with 1mm PVC.

Model #	Description	Price
T3032	Up To: 30" deep x 32" wide	***
T3038	Up To: 30" deep x 38" wide	***
T3044	Up To: 30" deep x 44" wide	***
T3050	Up To: 30" deep x 50" wide	***
T3056	Up To: 30" deep x 56" wide	***
T3062	Up To: 30" deep x 62" wide	***
T3068	Up To: 30" deep x 68" wide	***
T3074	Up To: 30" deep x 74" wide	***

DOUBLE FACED TOPS



1-1/4" thick, 3-ply particleboard with .050" high pressure laminate face and .020" phenolic backer on the underside. Both long edges will be Post Form (laminated). Remaining edges will be banded with 1mm PVC.

Model #	Description	Price
T5432	Up To: 54" deep x 32" wide	***
T5438	Up To: 54" deep x 38" wide	***
T5444	Up To: 54" deep x 44" wide	***
T5450	Up To: 54" deep x 50" wide	***
T5456	Up To: 54" deep x 56" wide	***
T5462	Up To: 54" deep x 62" wide	***
T5468	Up To: 54" deep x 68" wide	***
T5474	Up To: 54" deep x 74" wide	***

SINGLE FACED PANELS

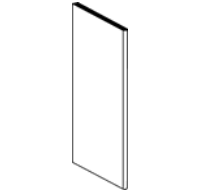

1-1/4" thick, 3-ply particleboard with .050" high pressure laminate face and .020" phenolic backer on the underside. One long edge will be Post Form (laminated). Remaining edges will be banded with 1mm PVC.

Model #	Description	Price
P1348	Up To: 13" wide x 48" tall	***
P1648	Up To: 16" wide x 48" tall	***
P1368	Up To: 13" wide x 68" tall	***
P1668	Up To: 16" wide x 68" tall	***
P1379	Up To: 13" wide x 79" tall	***
P1679	Up To: 16" wide x 79" tall	***
P1385	Up To: 13" wide x 85" tall	***
P1685	Up To: 16" wide x 85" tall	***
P1391	Up To: 13" wide x 91" tall	***
P1691	Up To: 16" wide x 91" tall	***

DOUBLE FACED PANELS

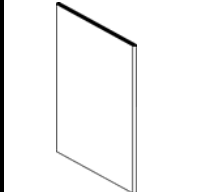

1-1/4" thick, 3-ply particleboard with .050" high pressure laminate face and .020" phenolic backer on the underside. Both long edges will be Post Form (laminated). Remaining edges will be banded with 1mm PVC.

Model #	Description	Price
P2248	Up To: 22" wide x 48" tall	***
P2648	Up To: 26" wide x 48" tall	***
P2268	Up To: 22" wide x 68" tall	***
P2668	Up To: 26" wide x 68" tall	***
P2279	Up To: 22" wide x 79" tall	***
P2679	Up To: 26" wide x 79" tall	***
P2285	Up To: 22" wide x 85" tall	***
P2685	Up To: 26" wide x 85" tall	***
P2291	Up To: 22" wide x 91" tall	***
P2691	Up To: 26" wide x 91" tall	***

***- SEE FACTORY FOR PRICING OF PANELS

ABOVE ITEMS ARE AVAILABLE IN 4-6 WEEKS.
CONTACT FACTORY FOR OTHER SIZES.

7/3 ELECTRICAL HARNESS SYSTEMS

Furnished by Electric cable Assembly Inc. Oof Orange, CT .

This Electrical Harness System is three circuit, 3 phase, 20 amp system that is fully UL Recognized.

Each workstation should be fitted with one triplex power module with three simplexes and an interconnecting cable. One power feed should be used for up to 15 workstations.

This system is available with an In-Line Surge Protectors. One #EILSP is required for each circuit. Use a suffix -1, -2, -3 to identify the circuits.

#EPM-SS	POWER MODULE TRIPLEX	\$ 40.00
#EPM-DS	POWER MODULE TRIPLEX- DOUBLE	\$ 46.00
#EIC-S	INTERCONNECTING CABLE, SHORT, UNDER 40"	\$ 90.00
#EIC-L	INTERCONNECTING CABLE, LONG, OVER 40"	\$ 110.00
#ECPF	CEILING POWER FEED, 130"	\$ 135.00
#ESPF	STARTER POWER FEED, 72" WALL OR FLOOR	\$ 88.00
#7API-48-24	20 AMP PLUG FEED 72" LONG	\$ 150.00
#7API-60-24	20 AMP PLUG FEED 84" LONG	\$ 175.00
#7API-120-2	20 AMP PLUG FEED 144" LONG	\$ 245.00
#ES-1	SIMPLEX RECT., CIRCUIT #1, #SS-1-BL	\$ 10.00
#ES-2	SIMPLEX RECT., CIRCUIT #2, #SS-2-BL	\$ 10.00
#ES-3	SIMPLEX RECT., CIRCUIT #IG, #SS-IG-OR	\$ 11.50
#EILSP	IN-LINE SURGE SUPPRESSION ONE REQUIRED PER CIRCUIT ALSO INCLUDES A 73FM-18- 18" INTERCONNECT	\$ 275.00
EPS-SS/F	POWER STRIP 6 OUTLET 72" CORD	\$ 209.00
EPS-SRG	POWER STRIP 6 OUTLET 84" CORD WITH SURGE PROTECTOR	\$ 243.00

Description	Weight
EC2727.5	24
C2727.5	20
ES327.5	42
IS327.5	34
DDEC2425	23
DDC2425	19
DDEI4425	38
DDI4425	30
CRL27.5	11
E Leg	11
EOR28	9
EOR34	11
EOR40	12
EOR46	14
EOR52	16
EOR58	18
EOR64	19
EOR70	21
EORC	2
EOR45D	4
E 32" Raceway	9
E 38" Raceway	11
E 44" Raceway	13
ED28	4
ED34	5
ED40	5
ED46	6
ED52	7
ED58	7
ED64	8
ED70	9
PF25	<1
PF27.5	1
PF33	<2
PF39	2
PANEL-E	1
CPUHOLDER	10
CASTOR3P	<1
CASTOR3PB	<1
DDBR	6
ADA18	10
ADA-E	2
EPMH-1	2
EK72	8
DMA12	21
DMA18	32
NOVA-S/F/R	30
KBD20	8
KBD30	15
KBD-E	8
S Hardware - Single	3
S Hardware - Double	6
E Hardware	1
FS2430	27
FS2436	32
FS2442	37
FS2448	42
FS2454	47
FS2460	52
FS2466	57
FS2472	62
FS3030	32
FS3036	39
FS3042	46
FS3048	53
FS3054	60
FS3060	67
FS3066	74
FS3072	81
DFS5430	60
DFS5436	71
DFS5442	82
DFS5448	93
DFS5454	104
DFS5460	115
DFS5466	126
DFS5472	137
DFS6030	67
DFS6036	80
DFS6042	93
DFS6048	106
DFS6054	119
DFS6060	132
DFS6066	145
DFS6072	158
ETCA2490	65
ETCA3090	70
TCRA2445	12
TCRA3045	15
TCRA2490	24
TCRA3090	30
FS0930	18
FS0936	23
FS0942	28
FS0948	33
FS0954	38
FS0960	43
FS0966	58
FS0972	53
FS1930	24
FS1936	29
FS1942	34
FS1948	39
FS1954	44
FS1960	49
FS1966	54
FS1972	59
FS2830	30
FS2836	36
FS2842	42
FS2848	47
FS2854	53
FS2860	59
FS2866	65
FS2872	70
FS2730E	30
FS2736E	36
FS2742E	42
FS3030E	32
FS3036E	39
FS3042E	45
ETCA2790E	67
ETCA3090E	70
TCRA2745E	13
TCRA3045E	15